

# **CLASSROOM AV CONTROL SYSTEM OPERATION MANUAL**

# INDEX

1. System Power-On	3
2. Overview	4
3. Table Box	6
4. Source Page	7
5. Notebook VGA	8
6. Notebook HDMI	9
7. Desktop	10
8. BLU-RAY Player	12
8. Visualizer Operation	13
9. Visualizer Selection	15
10. Table Video AUX	16
11. Other External Source	17
12. Controls	18
13. Media Volume Control	19
14. Microphone Volume Control	20
15. BLU-RAY Player Control	21
16. Projector Control	22
17. Screen Control	23

# OPERATION MANUAL - POWER ON SYSTEM

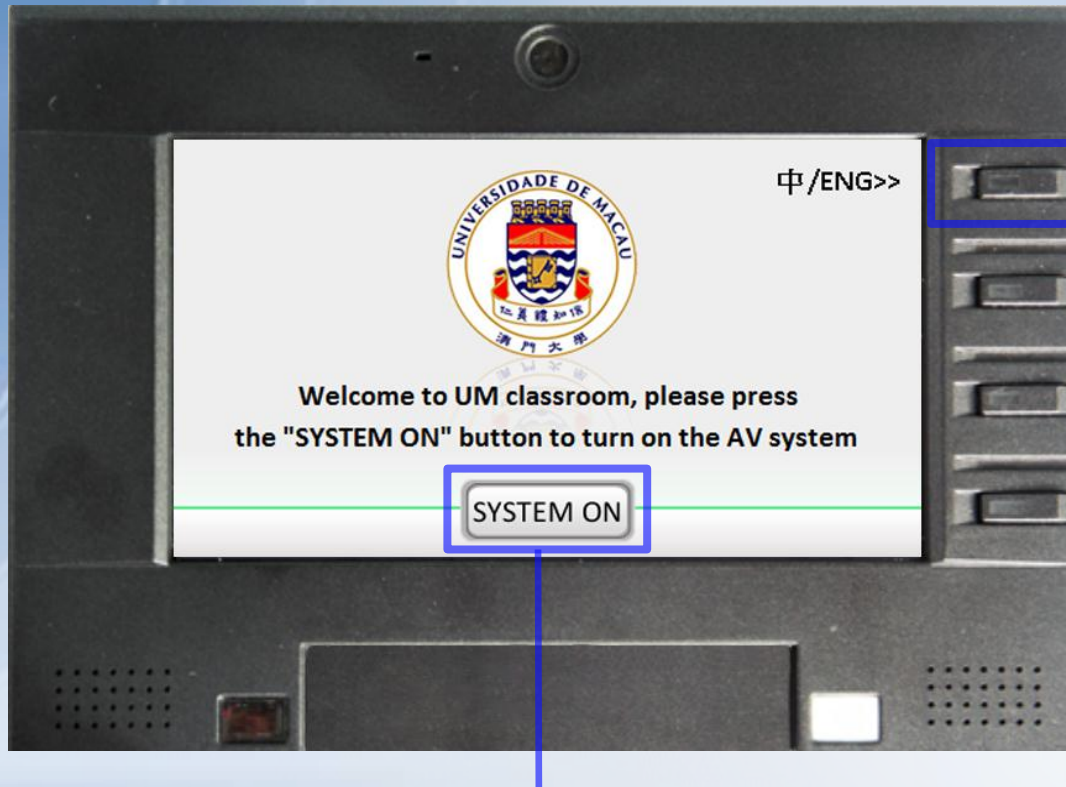

Switch language  
CHINESE / ENGLISH

Press the "SYSTEM ON" button  
and the system will turn on in 5 seconds.

# OPERATION MANUAL - OVERVIEW



NAVIGATION TAB

POWER OFF



# OPERATION MANUAL - OVERVIEW

Navigation Tab contains 3 pages: [Source](#), [Controls](#) and [Screen](#).

SOURCE

SCREEN



CONTROLS



# OPERATION MANUAL - TABLE BOX

Open the Table Box to get the appropriate cables.

NOTEBOOK HDMI  
CABLE

NOTEBOOK VGA AND  
AUDIO CABLE

TABLE VIDEO AUX  
CABLE

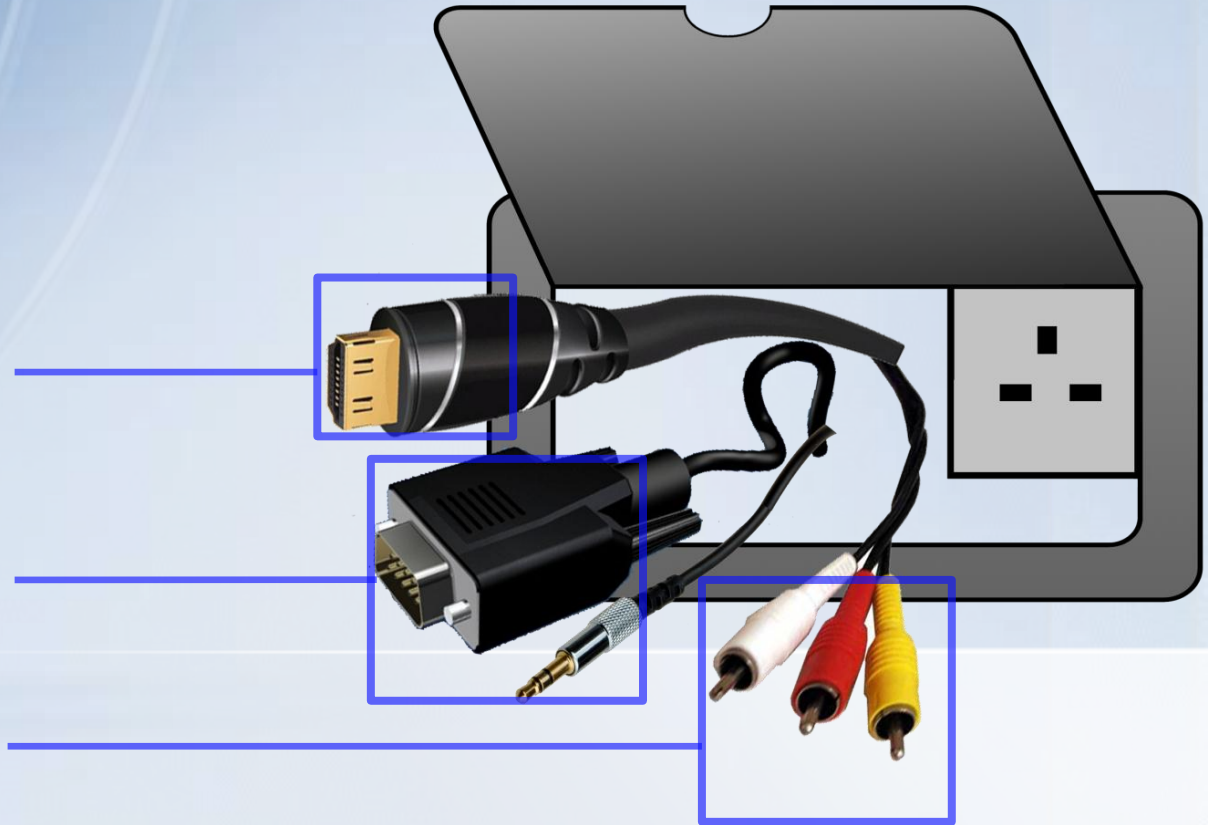

# OPERATION MANUAL - SOURCE PAGE

Source Page contains 2 pages.

Page 1

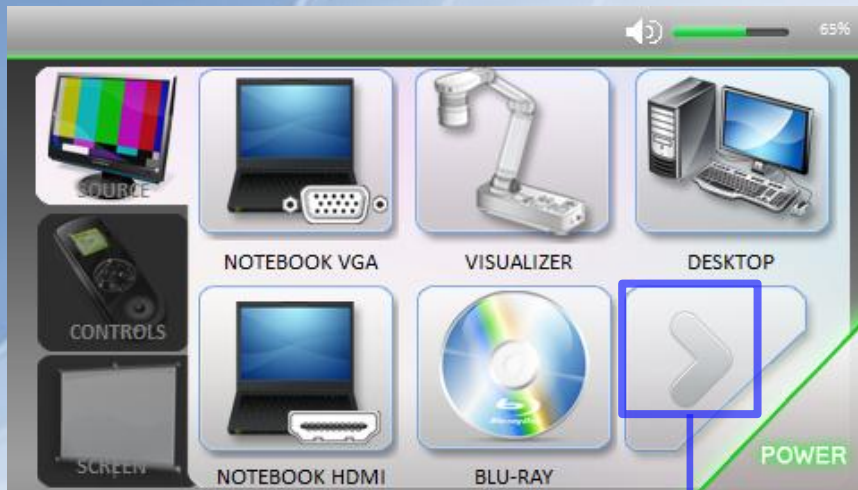

NEXT PAGE

Page 2



PREVIOUS PAGE

# OPERATION MANUAL - NOTEBOOK VGA

## Step 1

Connect the VGA cable on the desk to your notebook.



## Step 2

Press the "Notebook VGA" button.

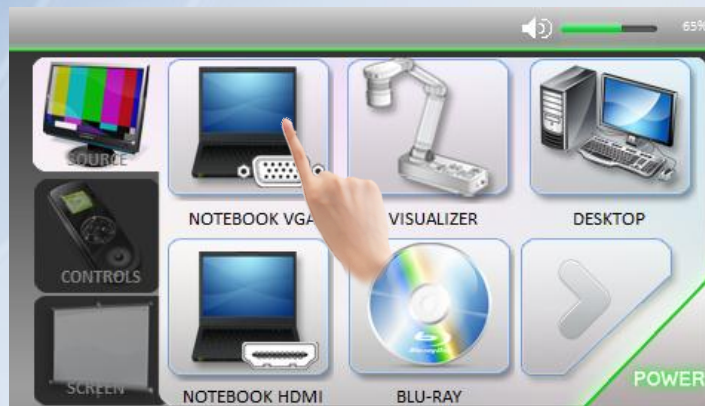

## Step 3

Press the appropriate function keys on your notebook for image output. The function keys locate among F1 - F12, on which there is a monitor icon or the words "CRT/LCD".





# OPERATION MANUAL - NOTEBOOK HDMI

## Step 1

Connect the HDMI cable on the desk to your notebook.



## Step 2

Press the "Notebook HDMI" button.



## Step 3

Press the appropriate function keys on your notebook for image output. The function keys locate among F1 - F12, on which there is a monitor icon or the words "CRT/LCD".



# OPERATION MANUAL - DESKTOP

Step 1

Turn on Desktop PC by pressing the "Power ON/OFF " button on desktop.



Step 2

Press the "DESKTOP" button.



# OPERATION MANUAL - BLU-RAY PLAYER

## Step 1

Turn on the BLU-RAY player by pressing the "ON/STANDBY" button.

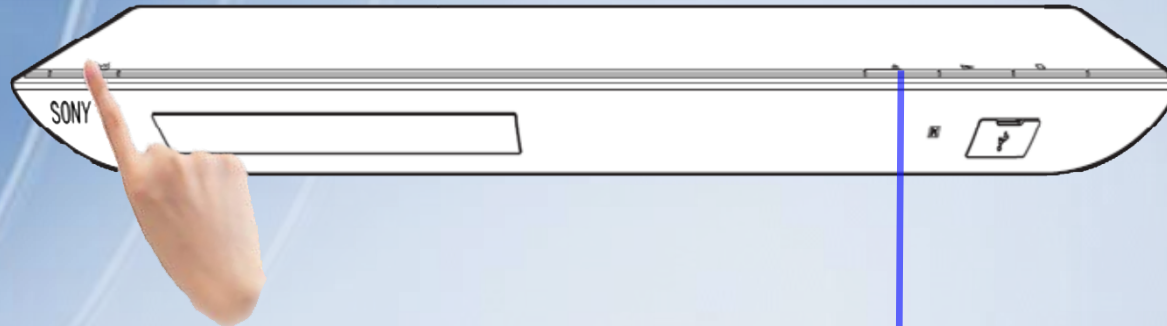

Press  button to open or close disk tray.

## Step 2

Press the "BLU-RAY" button.



# OPERATION MANUAL - BLU-RAY PLAYER

## Step 3

System will direct to BLU-RAY player control page automatically.

Press to show page 1



Press to show page 2





# OPERATION MANUAL - VISUALIZER OPERATION

## POWER ON

Turn on the visualizer by pressing the "ON/OFF" button.

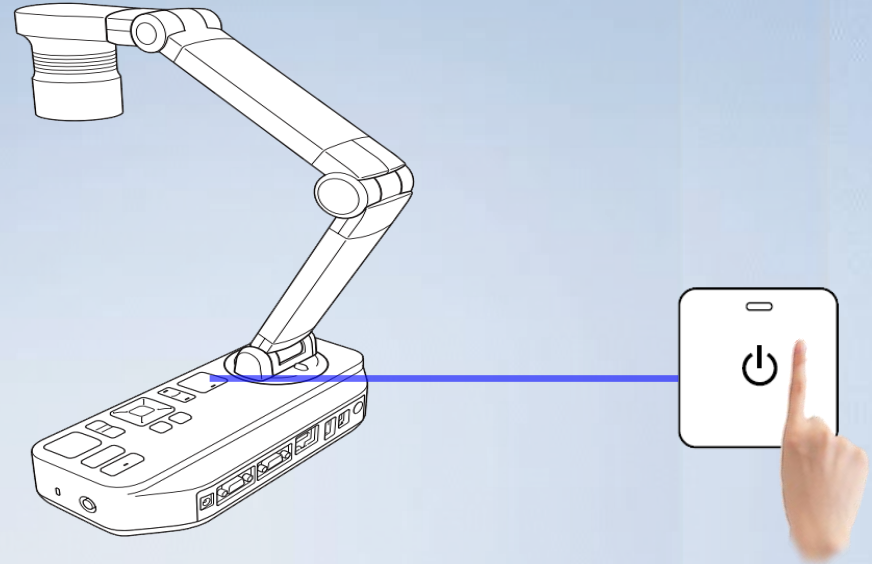

## LED LAMP

Press the "Lamp Switch" button to change the LED lamp status: bright, dim, and off.

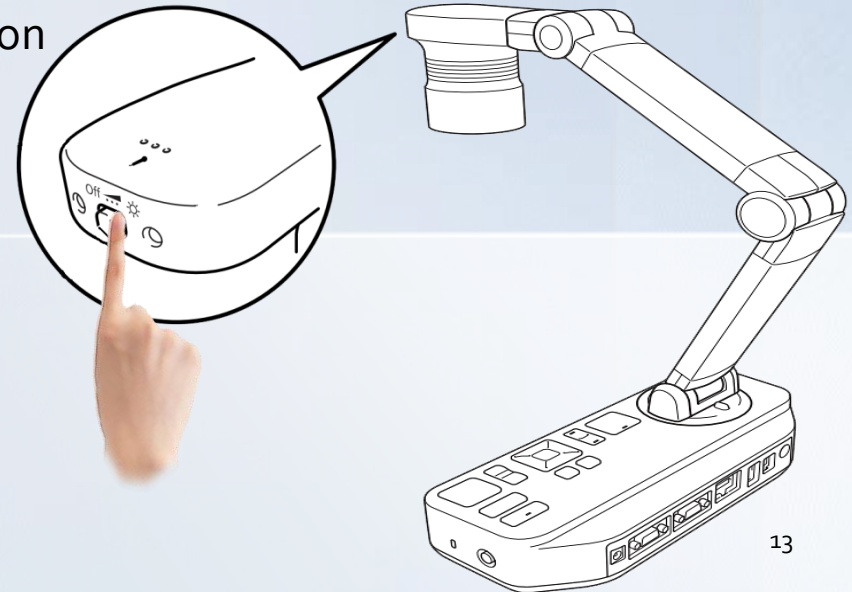

# OPERATION MANUAL - VISUALIZER OPERATION

## AUTO FOCUS

Press the "Focus" button to auto focus.

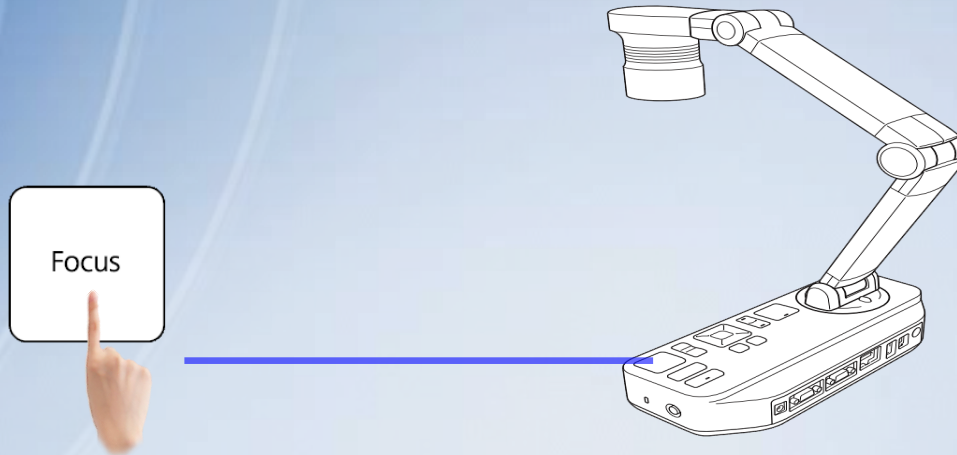

## ZOOM IN/OUT

The display range of the document can be adjusted by pressing the "Zoom In" and "Zoom Out" buttons.

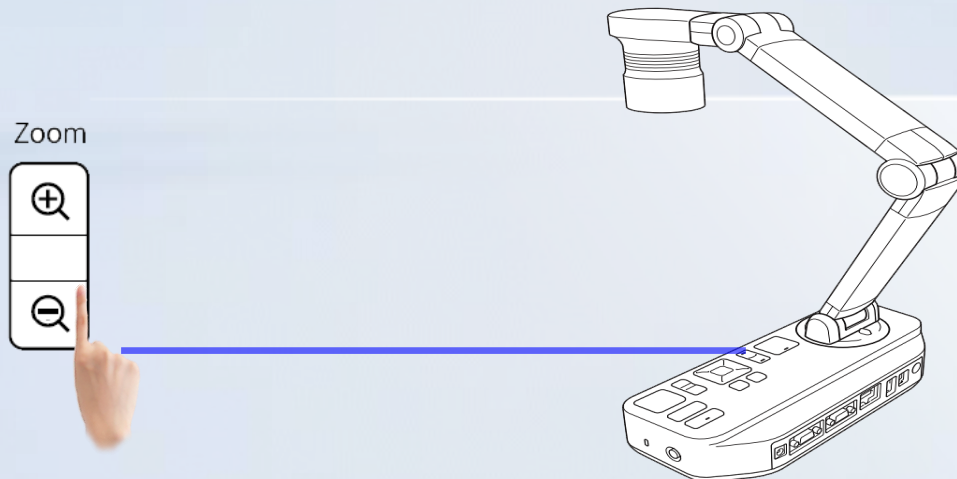

# OPERATION MANUAL - VISUALIZER SELECTION

## Step 1

Turn on the visualizer by pressing the "ON/OFF" button.

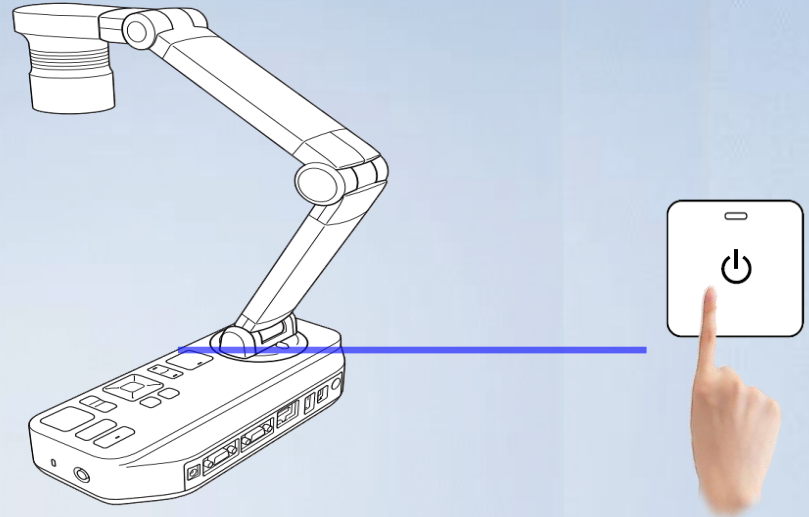

## Step 2

Press the "VISUALIZER" button.



# OPERATION MANUAL - TABLE VIDEO AUX

Table AUX is for external devices, such as VCR or portable sound systems, to connect the classroom AV system.

Step 1

Connect the RCA cable on the desk to your external device.



Step 2

Press the "TABLE AUX" button in Source Selection Page .





# OPERATION MANUAL - OTHER EXTERNAL SOURCE

Wall plate AUX function is for external devices to connect to classroom AV system.



VGA AUX



VIDEO AUX

# OPERATION MANUAL - CONTROLS

Controls Page contains 4 control functions:

Media Volume, MIC. Volume, BLU-RAY player and Projector.



Press to enter  
Controls page

# OPERATION MANUAL - MEDIA VOLUME CONTROL

Media Volume Control (Notebook, Table AUX, BLU RAY Player, VGA AUX, VIDEO AUX).

Step 1

Press the "MEDIA VOLUME" button or "MEDIA VOLUME BAR".

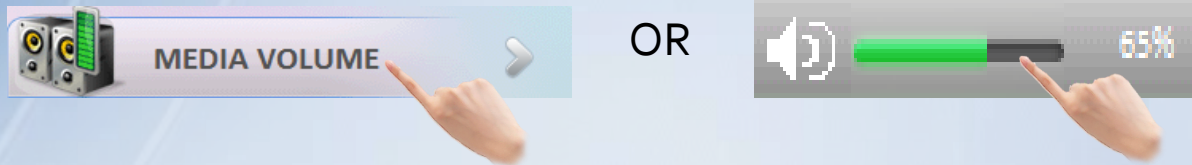

Step 2

"CONTROL FADER" determines the level of media volume.

RESET MEDIA  
VOLUME LEVEL

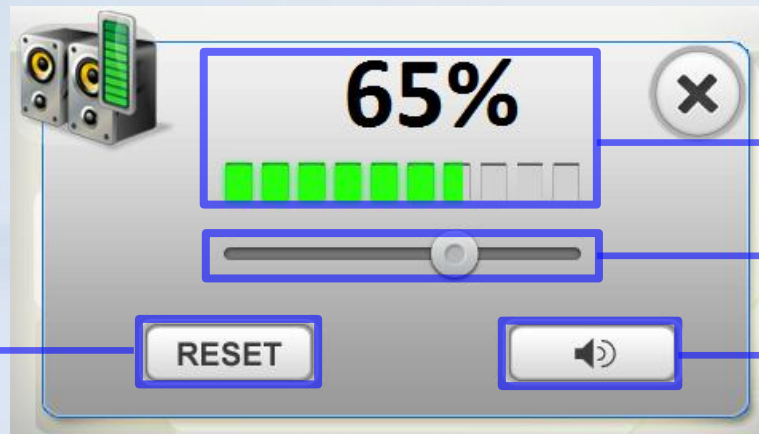

VOLUME LEVEL

CONTROL FADER

MUTE / UNMUTE

# OPERATION MANUAL - MICROPHONE VOLUME CONTROL

## Step 1

Press the "MIC. VOLUME" button.

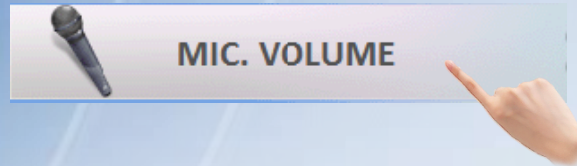

## Step 2

"CONTROL FADER" determines the level of microphone volume.

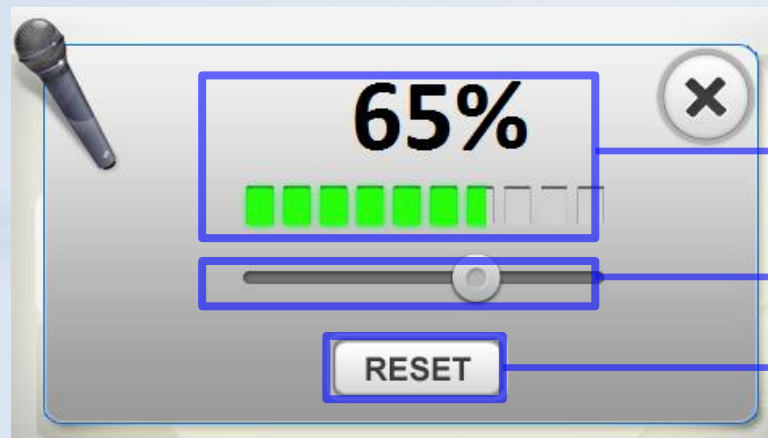

VOLUME LEVEL

CONTROL FADER

RESET MIC. VOLUME LEVEL



# OPERATION MANUAL - BLU-RAY PLAYER CONTROL

## Step 1

Press the "BLU-RAY PLAYER" button.

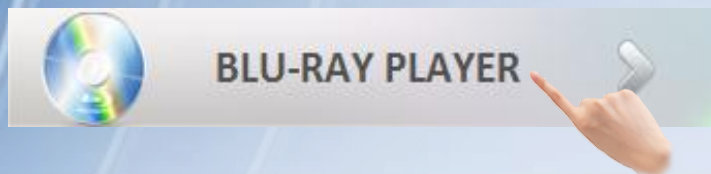

## Step 2

BLU-RAY player control page contains 2 pages.

Press to show page 1.



Press to show page 2.



# OPERATION MANUAL - PROJECTOR CONTROL

## Step 1

Press the "PROJECTOR" button.

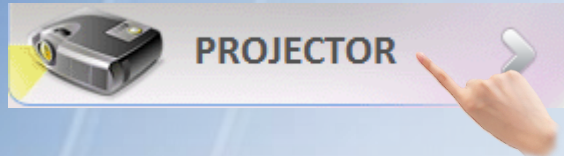

## Step 2

Press appropriate button to control projector screen.

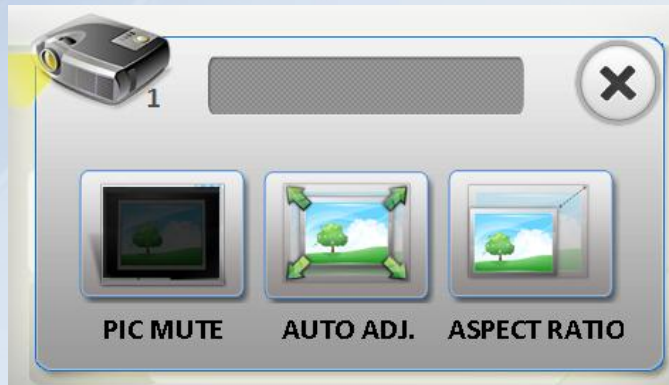

Mute /Unmute projector picture.



Auto adjust projector picture.

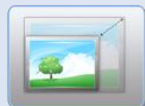

Change projector picture aspect ratio:  
16:9, 4:3 and normal.

# OPERATION MANUAL - SCREEN CONTROL

## Step 1

Press "SCREEN" button in Navigation Tab to enter screen control page.

Press to enter  
Screen Control  
page

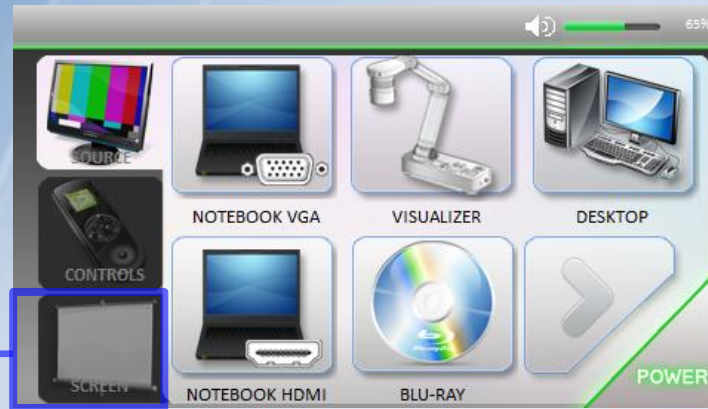

## Step 2

Press appropriate button to control screen.

